

2

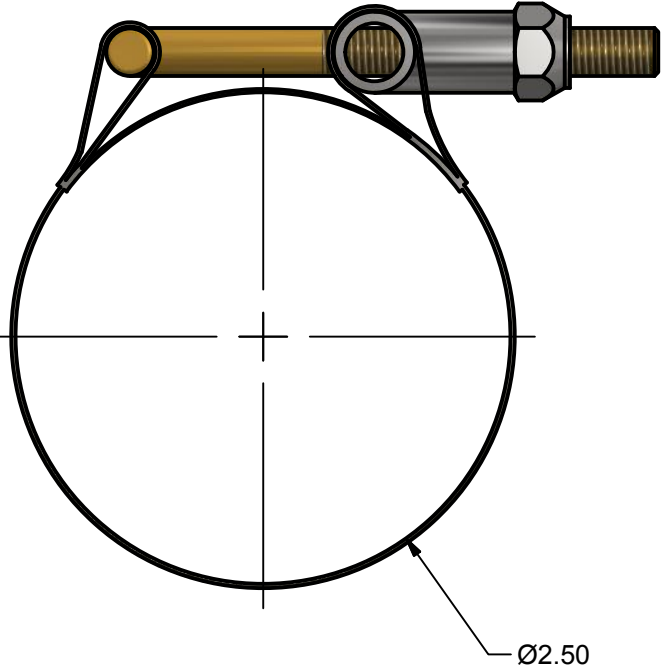

1



Ø2.50



.750



B

B



CUSTOMER: _____
APPROVED BY: _____ DATE: _____

PART NUMBER: 20222-96
PART IS STAINLESS STEEL

NOTES:

THESE DRAWINGS AND SPECIFICATIONS CONTAIN INFORMATION WHICH CONVERTER ACCESSORY CORPORATION CONSIDERS PROPRIETARY AND CONFIDENTIAL. NO PORTION OF THIS DRAWING MAY BE REPRODUCED OR COPIED WITHOUT PRIOR WRITTEN PERMISSION OF CONVERTER ACCESSORY CORPORATION.

CAC CONVERTER ACCESSORY CORP.
WIND GAP, PA 18091
WWW.CONVERTERACCESSORY.COM

TITLE
2.5" HIGH TORQUE DUCT CLAMP

SIZE A	DWG NO 18503-184A	REV A
DATE	DRAWN MEMAST	QUOTE NO.

2



1

A

A